





Lounge chair

Broadway









Broadway





HARDWOOD

-  Soaped oak
-  White oiled oak
-  Oiled oak
-  Oiled walnut
-  Black lacq. oak

SEMI-ANILINE LEATHER
RANGE: SPECTRUM

-  Ginger
-  Tan
-  Havana
-  Ruby
-  Moss
-  Black

ANILINE LEATHER
RANGE: SOFT

-  Natural
-  Cognac
-  Brown
-  Black

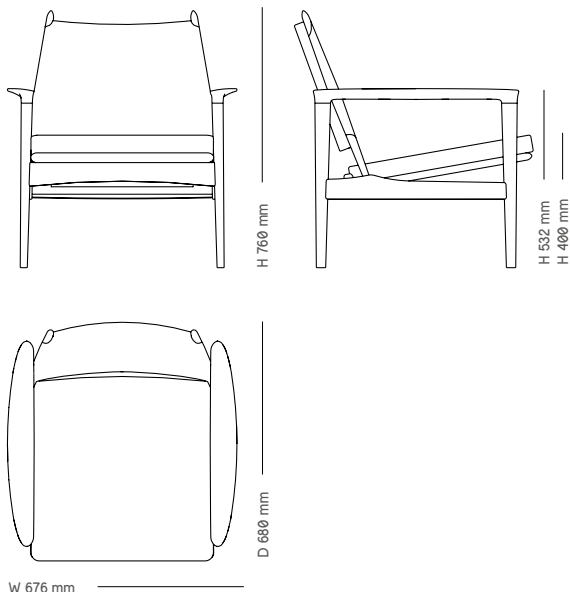

With its turned siderails pointing upwards as horns the lounge chair Broadway makes a strong statement. This is a chair that won Torbjørn Afdal a gold medal at the craftsmanship fair "So Wohnt Europa" in Munich in 1959. Afdal graduated from the Norwegian National Academy of Craft and Art Industry in 1946 and worked his whole career for the legendary Tegnekontoret Bruksbo. He designed the chair with extreme attention to detail: the shape and transition between legs and armrest is beyond words.

Designed in 1958