





Lounge chair

Broadway









Broadway





HARDWOOD

-  Soaped oak
-  White oiled oak
-  Oiled oak
-  Oiled walnut
-  Black lacq. oak

SEMI-ANILINE LEATHER RANGE: SPECTRUM

-  Ginger 30096
-  Tan 30108
-  Havana 30110
-  Ruby 30116
-  Moss 30128
-  Black 30114

ANILINE LEATHER RANGE: SOFT

-  Natural 8800
-  Cognac 95
-  Brown 8666
-  Black 8175

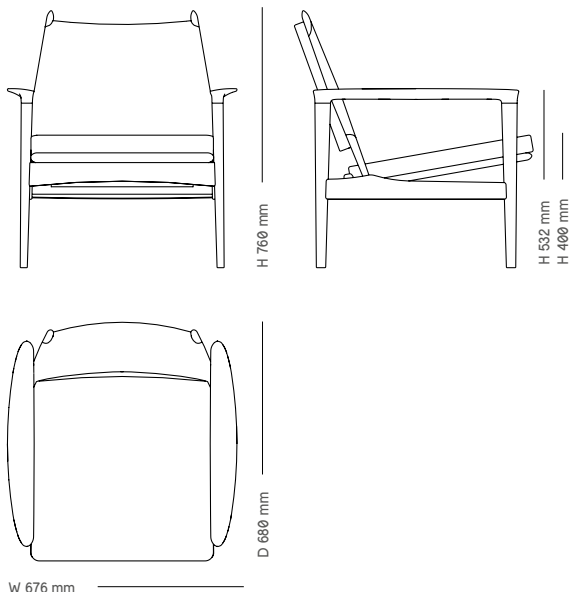

With its turned siderails pointing upwards as horns the lounge chair Broadway makes a strong statement. This is a chair that won Torbjørn Afdal a gold medal at the craftsmanship fair "So Wohnt Europa" in Munich in 1959. Afdal graduated from the Norwegian National Academy of Craft and Art Industry in 1946 and worked his whole career for the legendary Tegnekontoret Bruksbo. He designed the chair with extreme attention to detail: the shape and transition between legs and armrest is beyond words.

Designed in 1958